



**MANUAL – INSTALLATION**

---

# Price Square Diffusers

SPD/SCD Series

v001 – Issue Date: 02/03/23

© 2023 Price Industries Limited. All rights reserved.



# PRICE SQUARE DIFFUSERS

---

## TABLE OF CONTENTS

### **Product Overview**

Product Overview.....	3
Before You Start.....	4
Getting Started.....	4

### **Inner Core Installation Instructions**

Inner Core Removal.....	5
Inner Core Installation .....	6

### **Installation & Mounting Instructions**

Surface Mount Applications.....	8
Surface Mount: Into Framing or Blocking .....	9
Surface Mount: Hard Duct .....	11
T-Bar Applications .....	13
Snap-In Mounting.....	14
Spline Mounting .....	15
4TS Clip-On Recessed Spline Mounting.....	16
AM Torsion Spring For Armstrong Metalworks .....	17
AV for Armstrong Vector.....	18
Exposed Ceiling: Suspended Mounting .....	19
Exposed Application: Hard Duct.....	20

### **Air Baffle Installation Instructions .....21**

### **Sectorizing Baffle Installation Instructions .....24**

### **Fourth Cone Installation .....25**

### **Pattern Deflectors .....26**

### **Plaster Frame Installation Instructions**

Plaster Frame Without Mounting Clips.....	27
Plaster Frame With Mounting Clips.....	28

### **Parts List .....29**

# PRICE SQUARE DIFFUSERS

## PRODUCT OVERVIEW

### Overview

Price square diffusers provide a horizontal radial air pattern for rapid mixing and optimal comfort with low pressure drop and is an excellent choice for variable air volume application.

These installation instructions are applicable to the following models: SPD/ASPD, SPDLT/ASPDLT, SPDHI, SCD/ASCD, SCDA/ASDA and SCDAS.

**NOTE:** The images in the installation manual depict the SPD models, and may differ slightly from other listed models.

The diffusers have an outer frame (backpan) with removable or fixed inner core.

The diffuser will have one sticker located at the back of the backpan. For ease of troubleshooting assistance, replacement parts and general factory assistance, it is recommended that the order number and model line string be available for reference. This information can be found on the factory label.

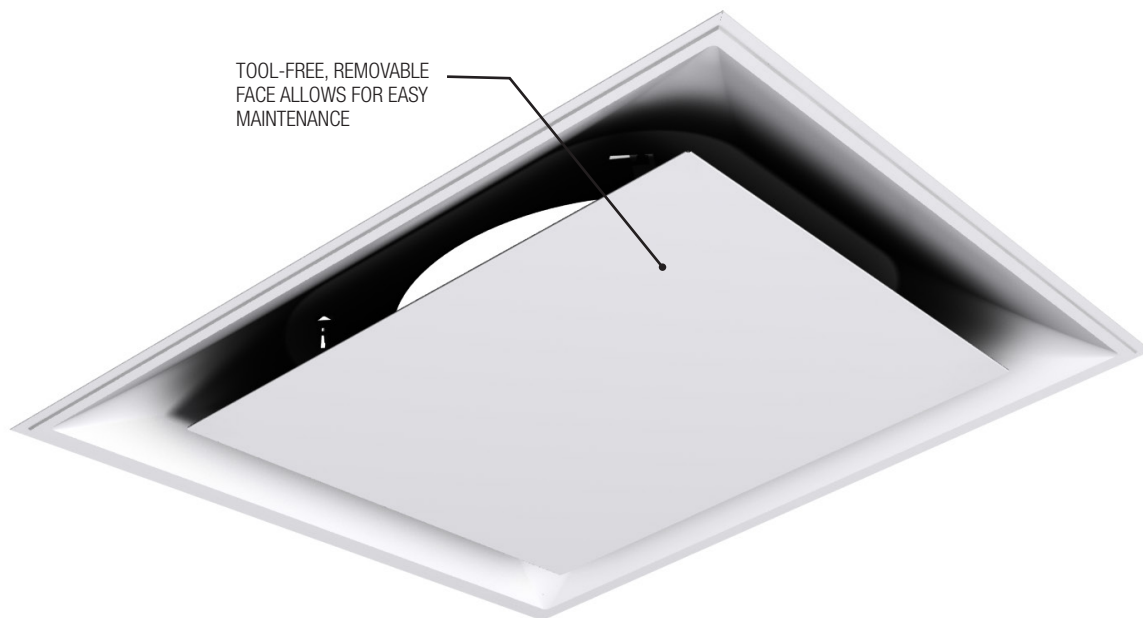

# PRICE SQUARE DIFFUSERS

## PRODUCT OVERVIEW

### Before You Start

Inspect all cartons and boxes for flaws and shipping damage. If anything is discovered to be damaged, contact the shipping company and file a freight claim.

### Getting Started

**Step 1:** Remove the diffuser from the shipping carton and inspect for any damages.

**Step 2:** Refer to factory label to determine the border type of the diffuser. For the following SPD line string: SPD-1-2//1/15//24/24/31/////B12, the frame style is 31.

**Step 3:** Use the adjacent table to find the appropriate reference page for a particular border type.

**NOTE:** The adjacent table is for units with removeable core. For fixed core units in surface mount installations, use of a plaster frame is recommended.

Border Type	Type of Mounting	Page Number
31	Surface Mount	8
31, 3P, 15, 15P, 17, 17P	T-Bar	13
2, 2P	Snap-In	14
4, 4P	Spline	15
4TS	Clip-On Recessed Spline	16
AM	Armstrong Torsion Spring	17
AV, AVP	Armstrong Vector	18
31	Exposed Ceiling	19

# PRICE SQUARE DIFFUSERS

## INNER CORE INSTALLATION INSTRUCTIONS

### Inner Core Removal

**NOTE:** Ordered units must have a removable core.

**Step 1:** Unclip all four plastic clips on each corner of the diffuser.



**Step 2:** Once unclipped, push the inner core slightly until the hook of the mounting legs comes loose.

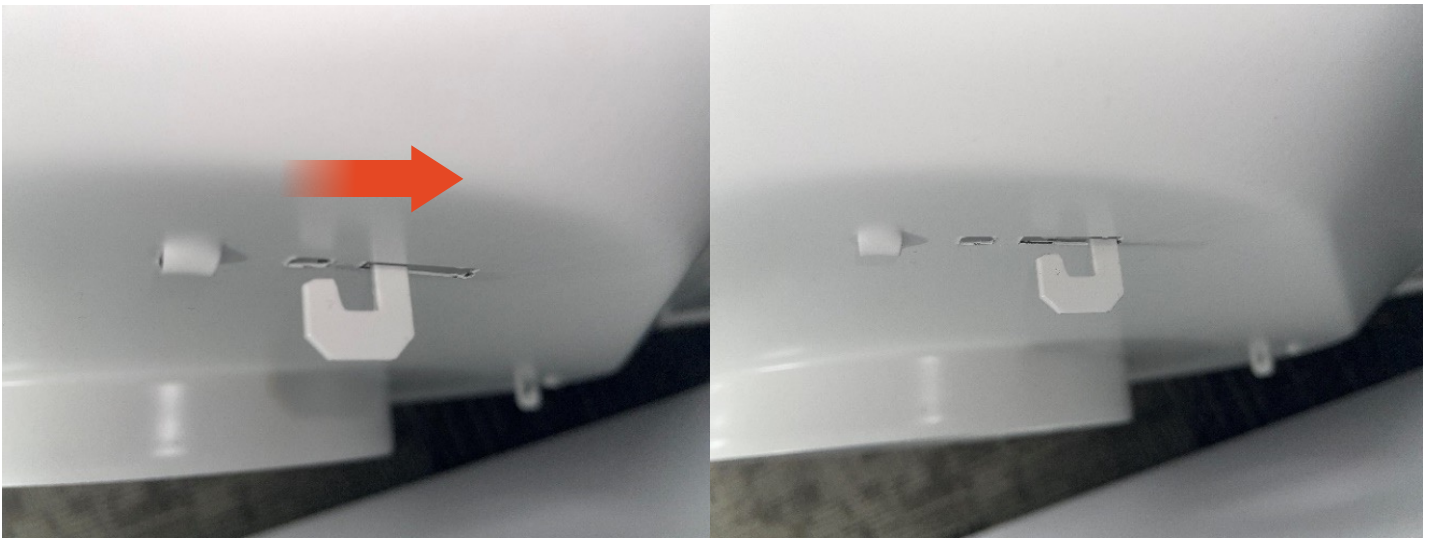

**Step 3:** Gently pull the inner core away from the back pan to completely remove the inner core.

**NOTE:** Make sure all four mounting legs are free before pulling.

# PRICE SQUARE DIFFUSERS

## INNER CORE INSTALLATION INSTRUCTIONS

### Inner Core Installation

**Step 1:** Before you start, make sure all the four plastic clips are attached to the mounting legs of the inner core. If they are not attached, insert the clips into the holes located on the inside of the mounting legs as shown below.

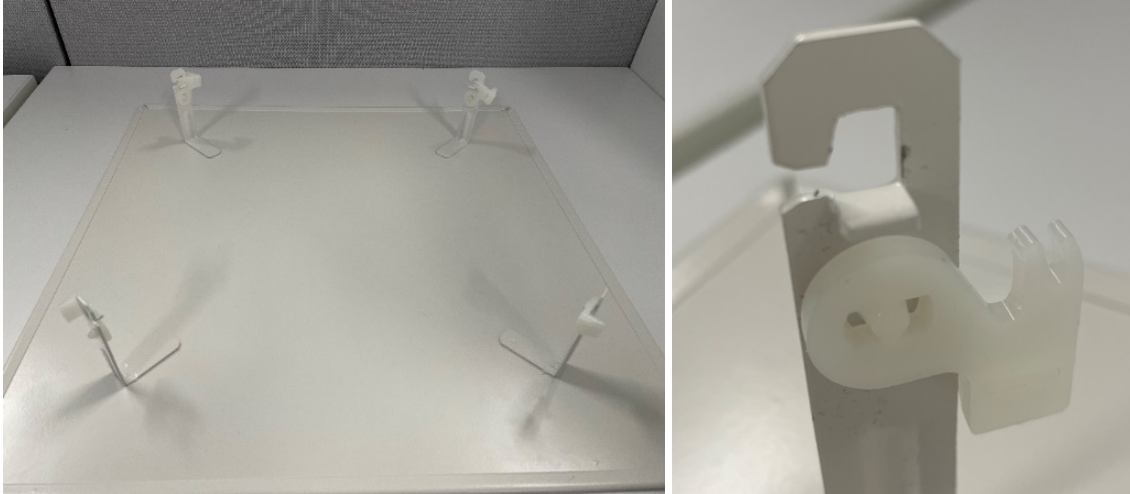

**Step 2:** Align the mounting legs to the four holes of the back pan.



# PRICE SQUARE DIFFUSERS

## INNER CORE INSTALLATION INSTRUCTIONS

**Step 3:** Gently push the inner core against the back pan to insert each of the mounting legs.



**Step 4:** Starting with one corner of the diffuser, make sure the mounting leg is inserted and attached properly. Use the plastic clip to lock it in place.

**NOTE:** All mounting legs must be pushed all the way down into the hole for the clips to lock properly.

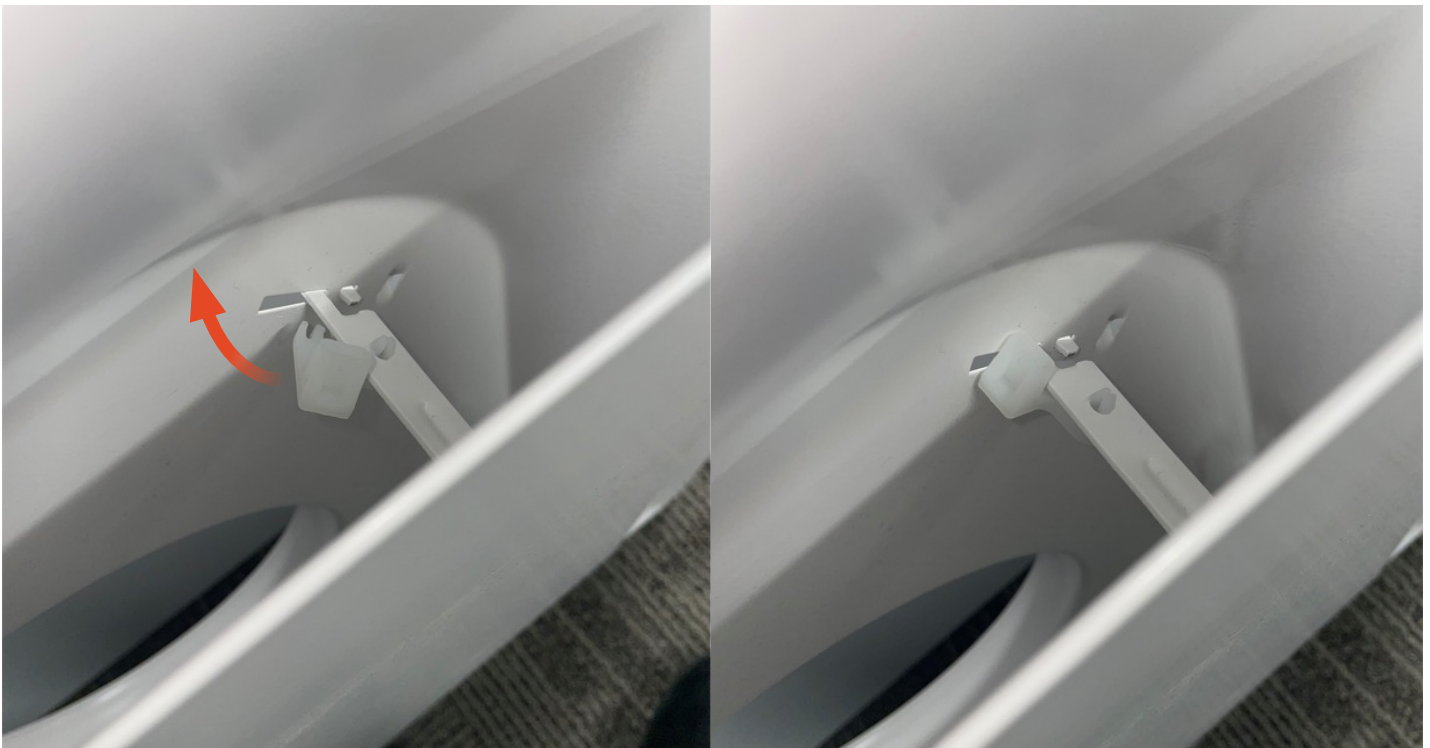

**Step 5:** Repeat Step 4 on each corner until all four corners lock in place.

# PRICE SQUARE DIFFUSERS

---

## INSTALLATION & MOUNTING INSTRUCTIONS

### Surface Mount Applications

#### Applicable Border Type: 31

**NOTE:** The unit must have removable core. For fixed core units in surface mount installations, use of a plaster frame is recommended.

Use the following table to find the reference page based on the type of installation:

Type of Installation	Page Number
Into Framing	9
Hard Duct	10

# PRICE SQUARE DIFFUSERS

## INSTALLATION & MOUNTING INSTRUCTIONS

### Surface Mount: Into Framing or Blocking

#### Applicable Border Type: 31

Sample line string: SPD-1-2//1/12//24/24/31/////B12

**Step 1:** Hang the duct work.

**Step 2:** Install the support framing. Refer to the table below for the framing opening dimensions for inlet sizes ranging from 4" to 12". The framing or blocking is parallel along the edge of the diffuser.

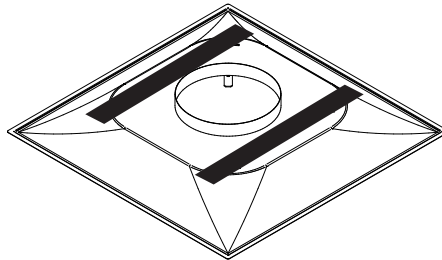

Diffuser Face Size	Framing Opening
12" x 12"	7.5" x 7.5"
20" x 20"	10" x 10"
24" x 24"	14" x 14"

For inlet sizes 14" and 15", framing or blocking must be positioned diagonally to screw the back pan to the framing. The frame opening for 14" and 15" inlet size is 15 1/8"x15 1/8".

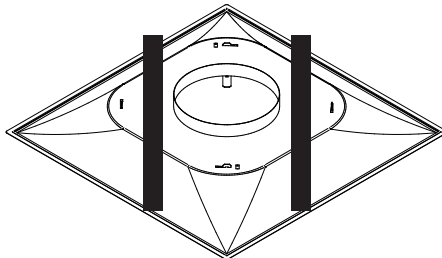

**Step 3:** Mount the drywall leaving an opening for the diffuser. Refer to the table below for ceiling opening.

Diffuser Face Size	Ceiling Opening
12" x 12"	10 1/2" x 10 1/2"
20" x 20"	18" x 18"
24" x 24"	22" x 22"

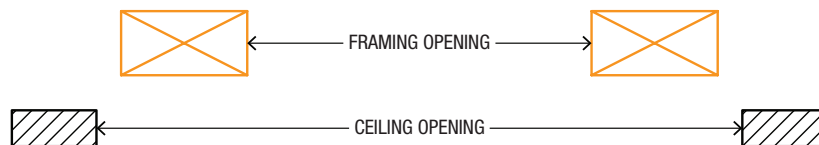

# PRICE SQUARE DIFFUSERS

## INSTALLATION & MOUNTING INSTRUCTIONS

**Step 4:** Remove the inner core of the diffuser from the back pan (see page 5).

**Step 5:** Attach and fasten the duct to the inlet of the diffuser.

**Step 6:** Once the diffuser is placed, screw the diffuser's back pan to the framing using self-tapping screws (by others).

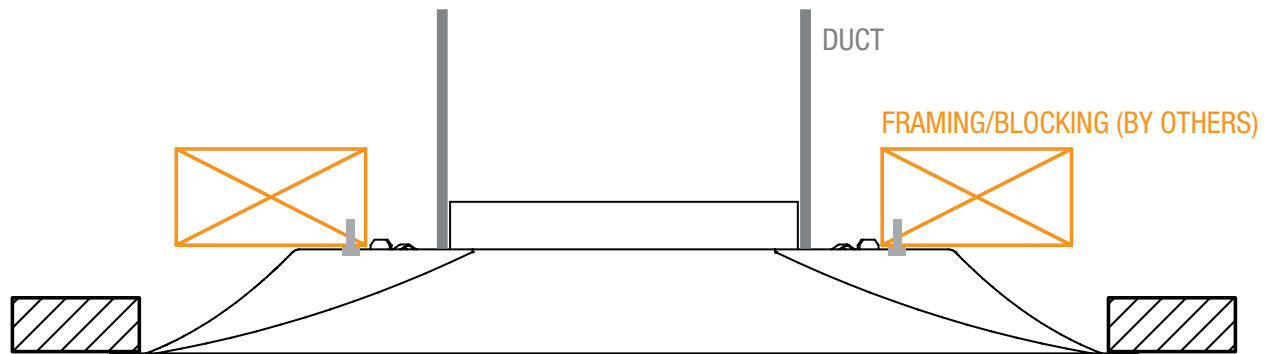

**Step 7:** When the back pan is securely fastened, reattach the diffuser's inner core assembly to the frame (see page 6).

# PRICE SQUARE DIFFUSERS

## INSTALLATION & MOUNTING INSTRUCTIONS

### Surface Mount: Hard Duct

#### Applicable Border Type: 31

Sample line string: SPD-1-2//1/12//24/24/31/////B12

**Step 1:** Remove the inner core from the back pan of the diffuser (see page 5).

**Step 2:** Cut the ceiling opening for the diffuser. See table below for the ceiling opening dimensions.

Diffuser Face Size	Ceiling Opening
12" x 12"	10-1/2" x 10-1/2"
20" x 20"	18" x 18"
24" x 24"	22" x 22"



**Step 3:** Hang the hard duct. Adjust the height based on the height of the inlet's neck (see table below). For beaded extended neck option, please contact GRD Application Team.

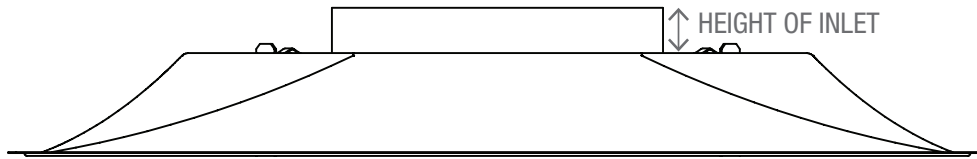

Module Size (in)	12 x 12	20 x 20	24 x 24
Inlet Size (in)	Height of the Inlet's Neck [in]		
4	0.75	--	0.75
5	0.75	--	0.75
6	1.062	1.06	1.06
7	1.125	--	1.06
8	1.188	1.06	1.06
10	--	1.15	1.15
12	--	--	1.15
14	--	--	1.15
15	--	--	1.15

# PRICE SQUARE DIFFUSERS

## INSTALLATION & MOUNTING INSTRUCTIONS

**Step 4:** Raise the back pan of the diffuser into the ceiling opening and slide the inlet into the hard duct.

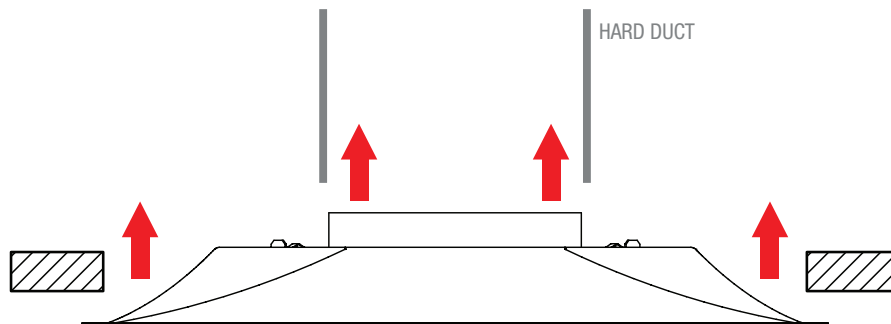

**Step 5:** When the back pan is in place, screw the inlet to the hard duct work.

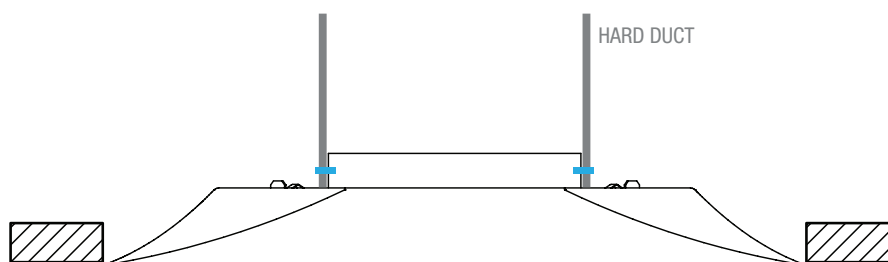

**Step 6:** Reattach the inner core of the diffuser (see page 6).

# PRICE SQUARE DIFFUSERS

## INSTALLATION & MOUNTING INSTRUCTIONS

### T-Bar Applications

**Applicable Border Type: 31, 3P, 15, 15P, 17 and 17P**

Sample line string: SPD-1-2//1/12//24/24/**31**////B12

**NOTE:** For 9/16" flat tee installation with frame style 31, cross-tees must be firmly secured. Locking any unopposed cross tees to the main beam with clips such as Armstrong STAC is recommended. Corner clips from the ceiling supplier may also be used or order 916 clips in GRD-PARTS. Price recommends confirming the fit with the ceiling on site first before purchasing the 916 clips

**Step 1:** Lay the diffuser into the T-bar ceiling grid. Note: Access through adjacent panel required.

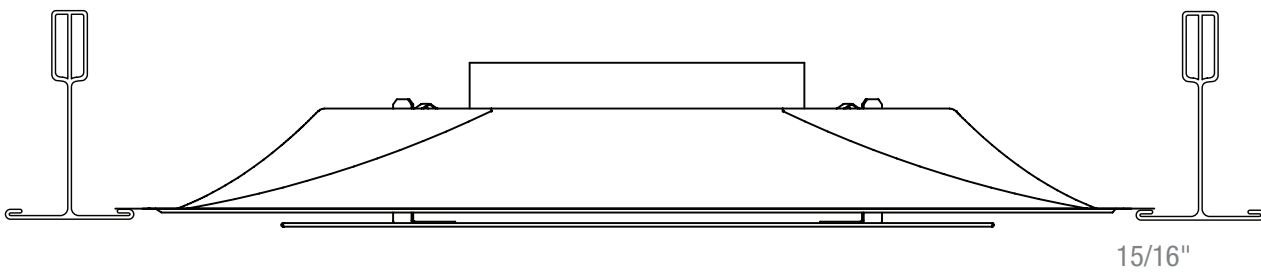

**Step 2:** Mount and secure the duct to the diffuser's inlet.

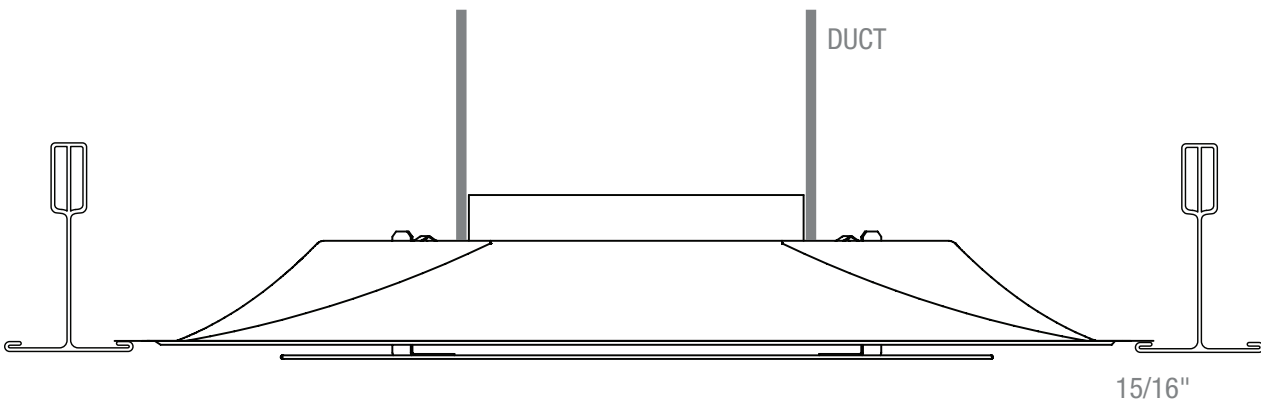

# PRICE SQUARE DIFFUSERS

## INSTALLATION & MOUNTING INSTRUCTIONS

### Snap-In Mounting

**Applicable Border Types: 2, 2P**

*Sample line string: SPD-1-2//1/12//24/24/2//B12*

**Step 1:** Align the edges of the diffuser along the bottom of the ceiling panels. Note: Access through adjacent panel required.

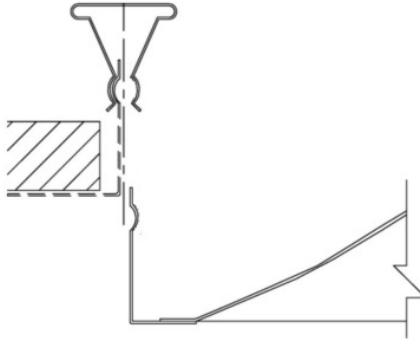

**Step 2:** Push it upwards with the palm of the hand until it snaps into place.

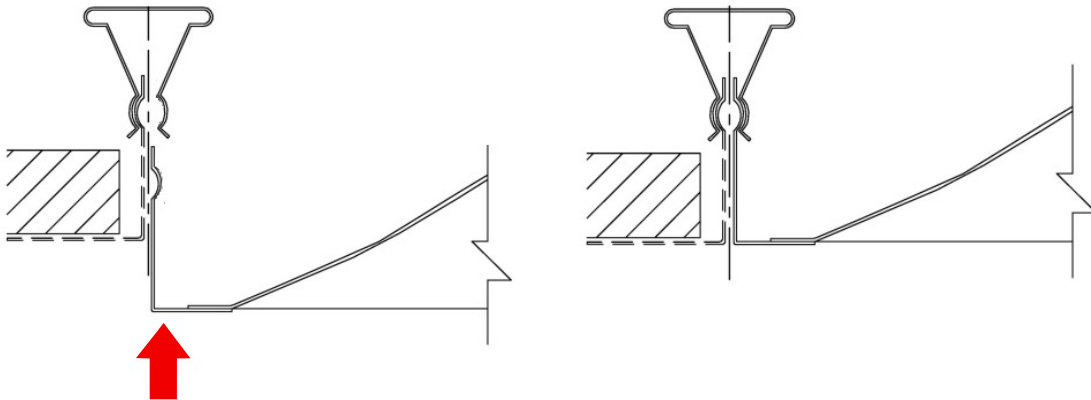

**Step 3:** Attach and secure the duct to diffuser's inlet.

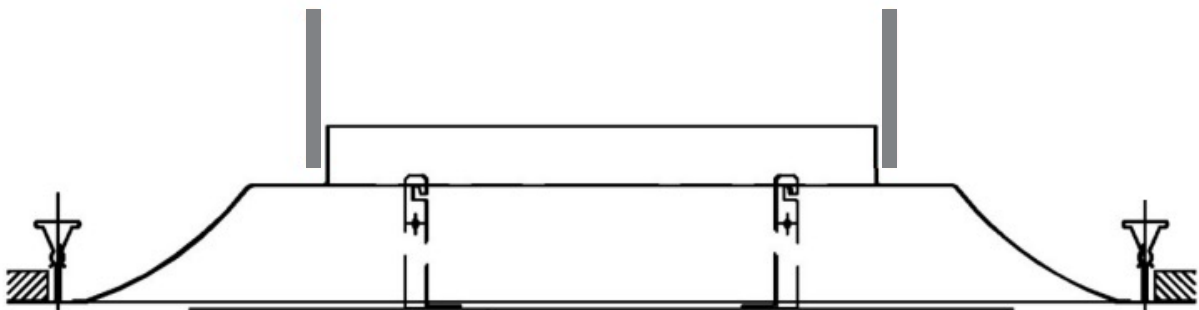

# PRICE SQUARE DIFFUSERS

## INSTALLATION & MOUNTING INSTRUCTIONS

### Spline Mounting

**Applicable Border Types: 4, 4P**

*Sample line string: SPD-1-2//1/12//24/24/4////B12*

Installation varies according to your ceiling system. Please reach out to your ceiling manufacturer for installation instructions.

### Border: 4P Spline Panel

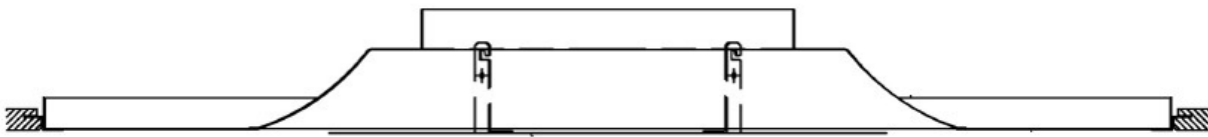

### Border: 4 Spline

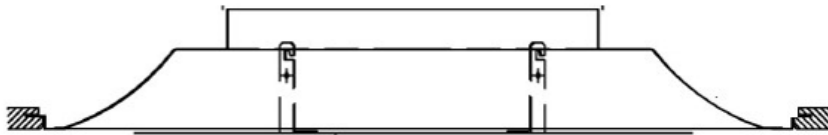

# PRICE SQUARE DIFFUSERS

## INSTALLATION & MOUNTING INSTRUCTIONS

### 4TS Clip-On Recessed Spline Mounting

Applicable Border Types: 4TS

Sample line string: SPD-1-2//1/12//24/24/4TS/////B12

**Step 1:** Hang the ceiling grid and the panels using hanger wire (by others). The ceiling module is based on the diffuser face size.

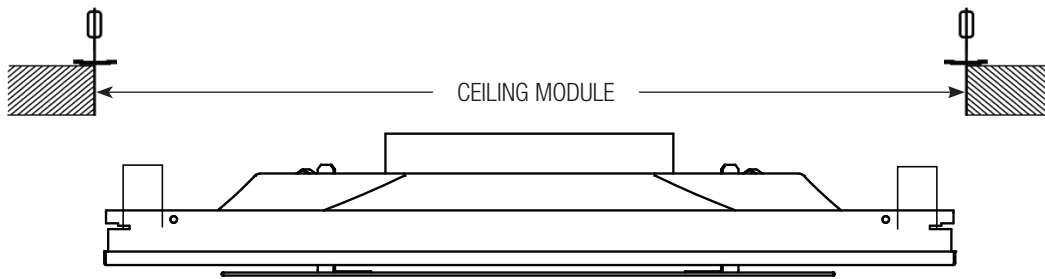

**Step 2:** Tilt the diffuser and insert one side of the diffuser with the 4TS clip-on to the tee.

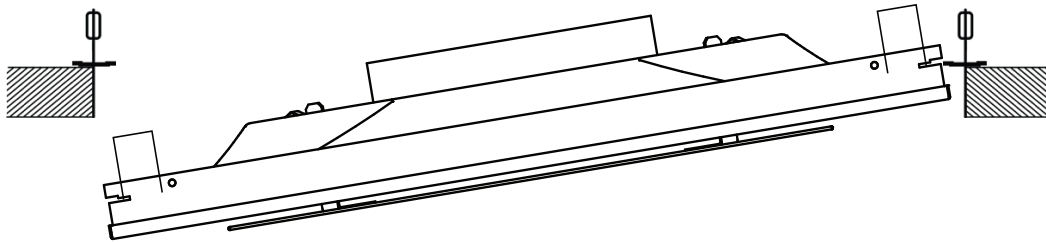

**Step 3:** Push the diffuser as far as it can go to insert the other side onto the tee.

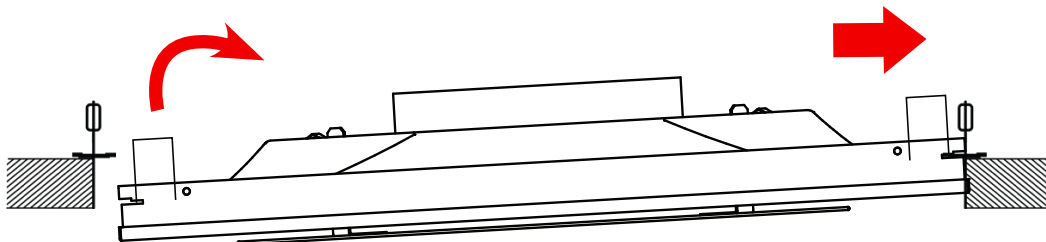

**Step 4:** Make sure the diffuser is centered, then attach and secure the duct to the diffuser's inlet. Note: Access through adjacent panel required.

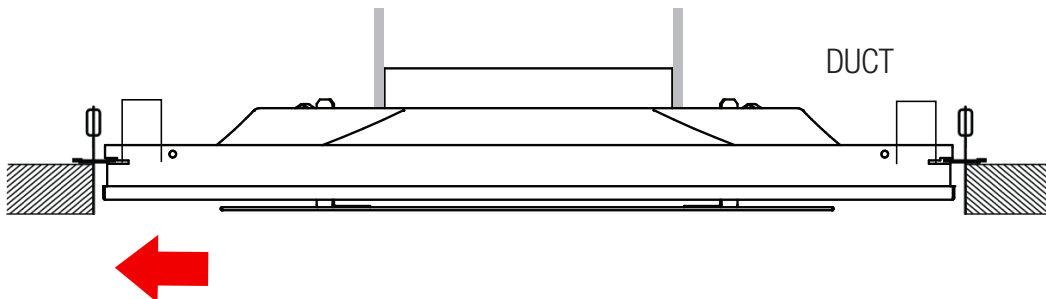

# PRICE SQUARE DIFFUSERS

## INSTALLATION & MOUNTING INSTRUCTIONS

### AM Torsion Spring For Armstrong Metalworks

Applicable Border Types: AM

Sample line string: SPD-1-2//12//24/24/AM/////B12

**Step 1:** Hang the ceiling grid and the ceiling panels with the torsion spring. The ceiling module is based on the diffuser face size.



**Step 2:** Tilt the diffuser and insert one side of the diffuser onto the torsion spring tee.

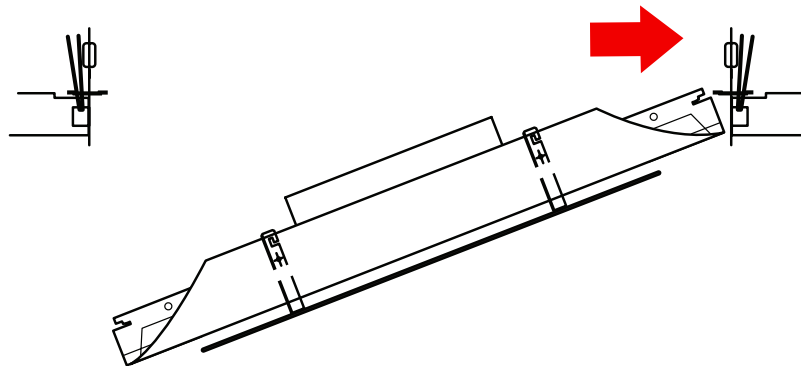

**Step 3:** Push the diffuser as far as it can go and insert the other side to the opposite torsion spring tee.

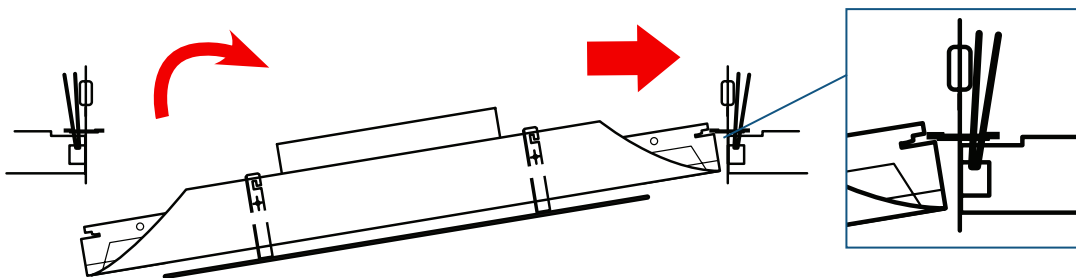

**Step 4:** Make sure the diffuser is centered and secure the duct to the inlet of the diffuser. Note: Access through adjacent panel required.

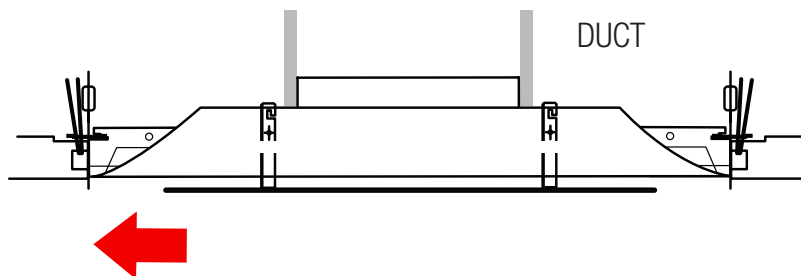

# PRICE SQUARE DIFFUSERS

## INSTALLATION & MOUNTING INSTRUCTIONS

### AV for Armstrong Vector

Applicable Border Types: AV and AVP

Sample line string: SPD-1-2//1/12//24/24/AV/////B12

**Step 1:** Hang the ceiling grid and the panels using hanger wire (by others). The ceiling module is based on the diffuser face size.

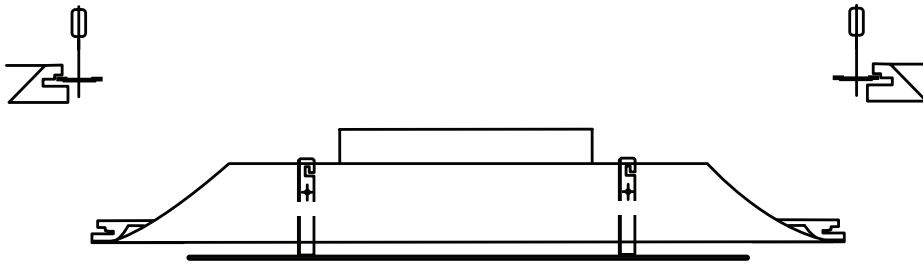

**Step 2:** Tilt the diffuser and insert one side of the diffuser onto the vector tee.

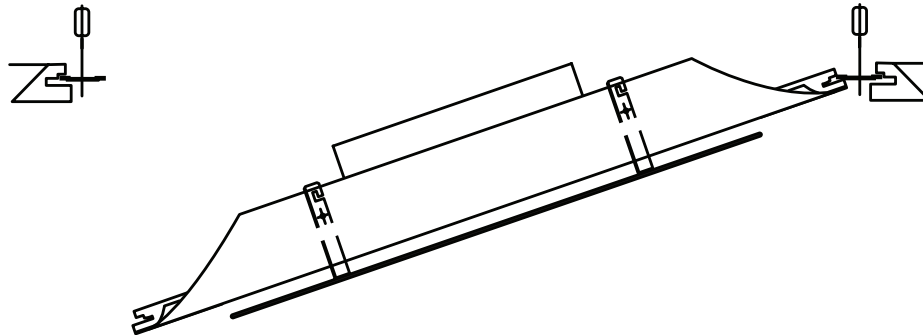

**Step 3:** Push the diffuser as far as it can go to insert the other side onto the other tee.

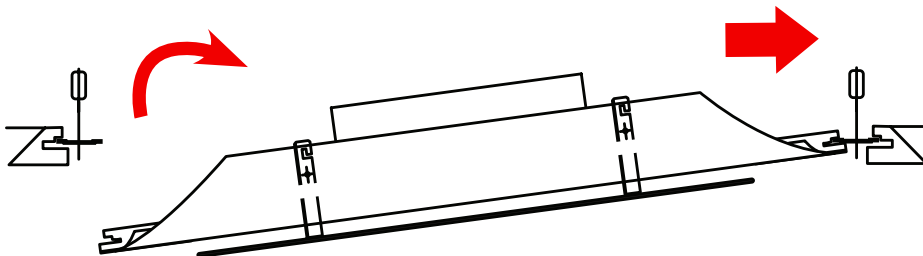

**Step 4:** Make sure the diffuser is centered, then attach and secure the duct to the diffuser inlet. Note: Access through adjacent panel required.

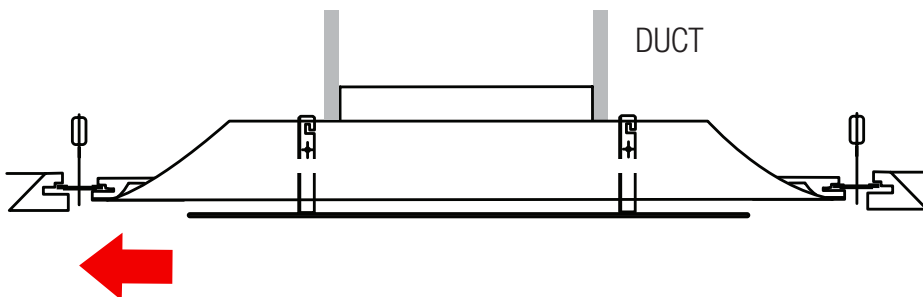

# PRICE SQUARE DIFFUSERS

## INSTALLATION & MOUNTING INSTRUCTIONS

### Exposed Ceiling: Suspended Mounting

#### Applicable Border Type: 31

Sample line string: SPD-1-2///12//24/24/31/////B12

**Step 1:** Attach the ducting to the diffuser's inlet.

**Step 2:** Attach the hanger straps or wires (by others) to the back of the diffuser. The standard hanger loops are typically used to hang the diffuser with hanger wires.

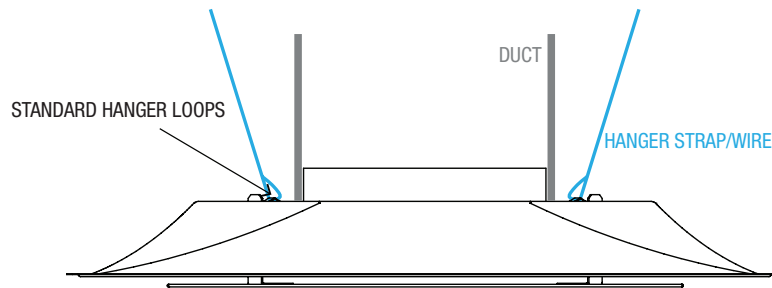

**Step 3:** Attach and secure the hanger straps or wires to the structure.

# PRICE SQUARE DIFFUSERS

## INSTALLATION & MOUNTING INSTRUCTIONS

### Exposed Application: Hard Duct

**Step 1:** Hang the hard duct. Refer to the table below for inlet neck heights.

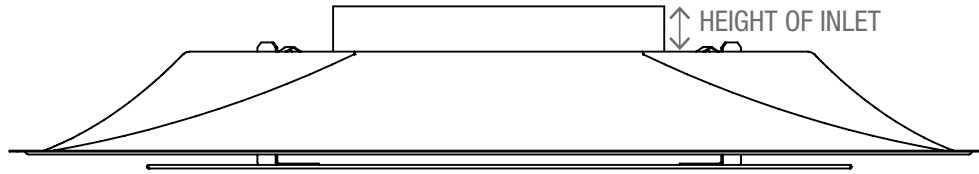

Module Size [in]	12 x 12	20 x 20	24 x 24
<b>Inlet Size [in]</b>	<b>Height of the Inlet's Neck [in]</b>		
4	0.75	--	0.75
5	0.75	--	0.75
6	1.062	1.06	1.06
7	1.125	--	1.06
8	1.188	1.06	1.06
10	--	1.15	1.15
12	--	--	1.15
14	--	--	1.15
15	--	--	1.15

**Step 2:** Raise the back pan of the diffuser and slide the inlet into the hard duct work.

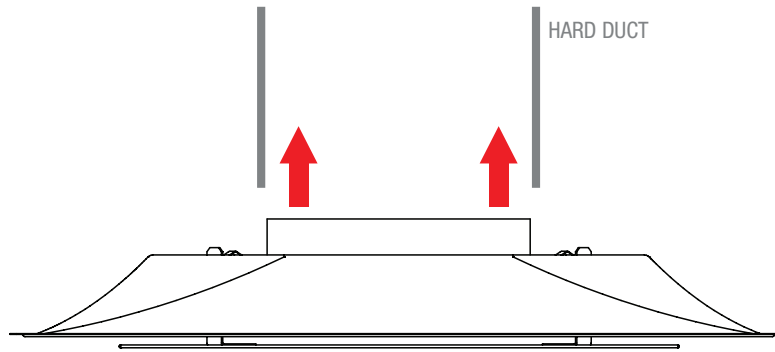

**Step 3:** Screw the back pan's inlet to the hard duct work.

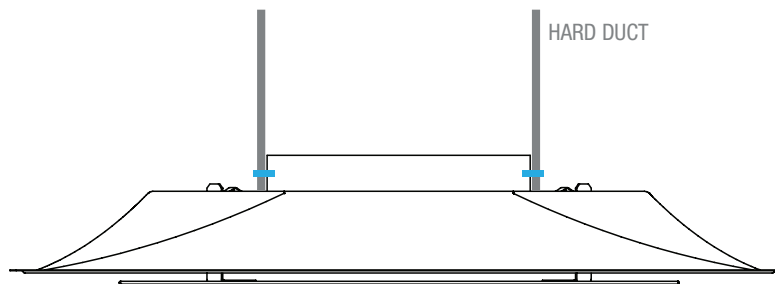

# PRICE SQUARE DIFFUSERS

## AIR BAFFLE INSTALLATION INSTRUCTIONS

Applicable models: SPD and ASPD

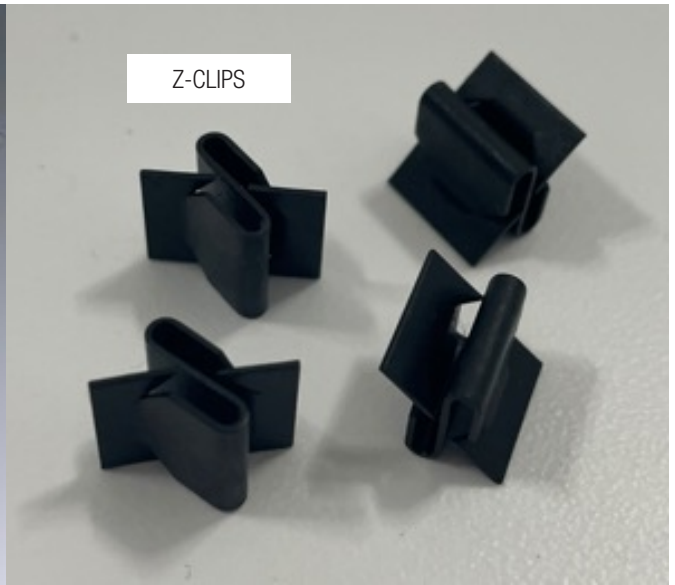
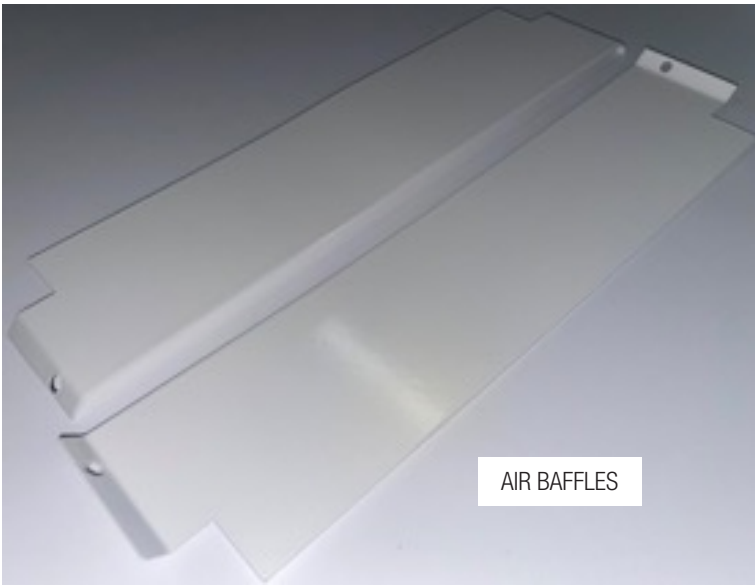

**Step 1:** Remove the inner core of the diffuser (see page 5).

**Step 2:** Put the clips on the air baffles (AB). Make sure the baffle is connected to the outer slot of the clip instead of the inner slot and place the 'Z' clips above the existing hole on the baffle.

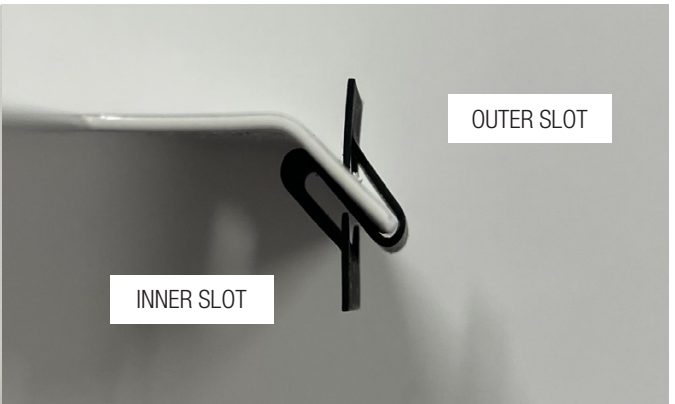

# PRICE SQUARE DIFFUSERS

## AIR BAFFLE INSTALLATION INSTRUCTIONS

**Step 3:** Align the air baffle to the mounting legs. The baffle should be mounted between the mounting legs using the inner slot.

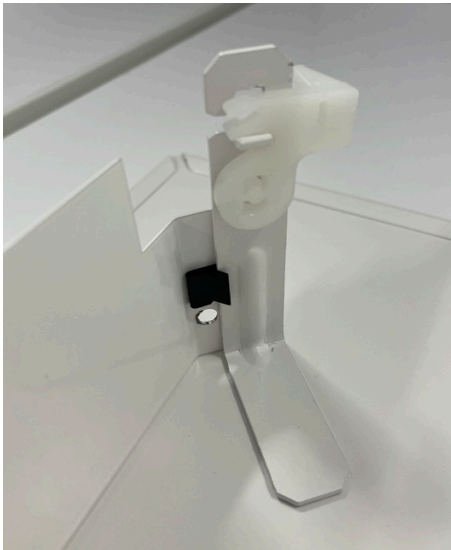

**Step 4:** Slide one of the air baffle clips onto the mounting leg.



# PRICE SQUARE DIFFUSERS

## AIR BAFFLE INSTALLATION INSTRUCTIONS

**Step 5:** Gently bend the baffle until the other clip can be inserted into the other mounting leg.



**Step 6:** Repeat steps 4 and 5 for each air baffle to install.



**Step 7:** Reattach the inner core of the diffuser (see page 6).

# PRICE SQUARE DIFFUSERS

## SECTORIZING BAFFLE INSTALLATION INSTRUCTIONS

**Applicable Models: SPD, ASPD, SCD and ASCD with round inlets only**

**Step 1:** Insert the sectorizing baffle into the square cone diffuser's round inlet.

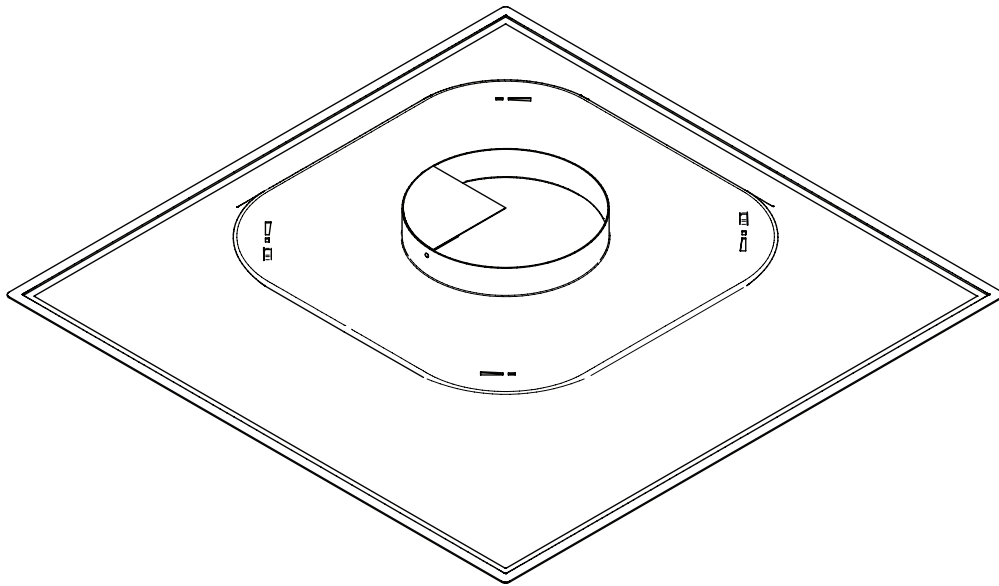

**Step 2:** Screw the sectorizing baffles directly to the round inlet.

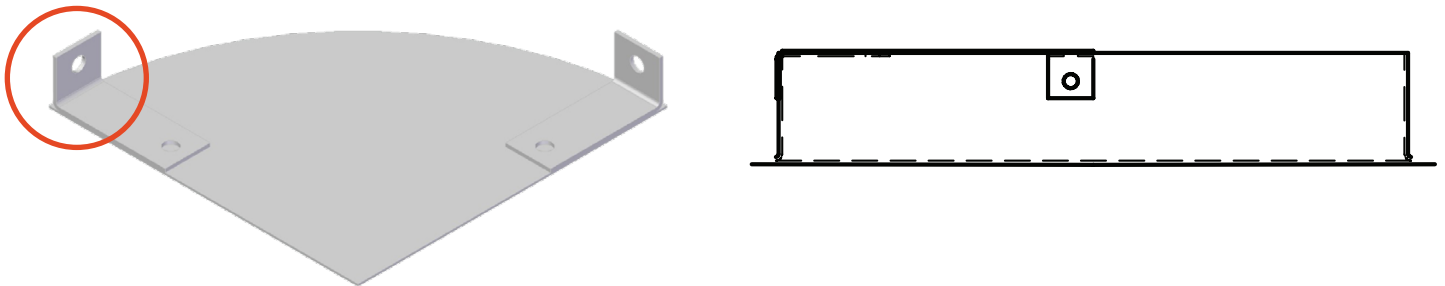

**Step 3:** Depending on the air pattern, repeat the previous steps according to the air pattern selected and number of baffles.

# PRICE SQUARE DIFFUSERS

## FOURTH CONE INSTALLATION

### 24" x 24" SCD and ASCD only

**Step 1:** Remove the plug button on the third inner cone of the square cone diffuser.

**NOTE:** The fixed core option has a plastic plug button and should be easy to remove. The removable core option has a metal plug button that may require more force to remove.

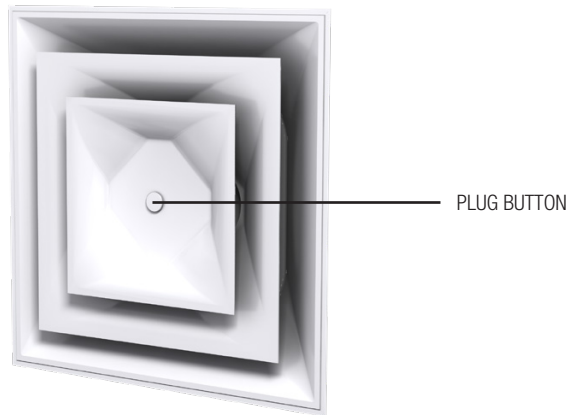

**Step 2:** Insert the fourth cone at the hole until the spring clips match onto the third inner cone.

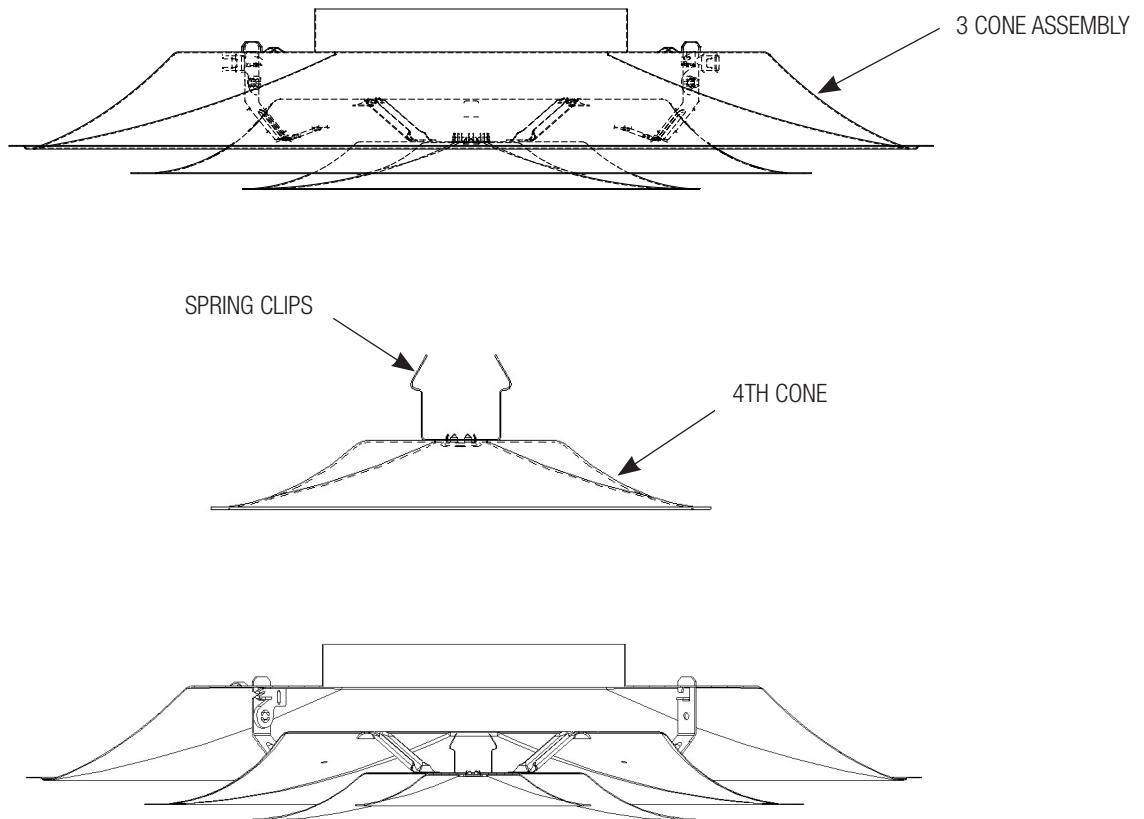

# PRICE SQUARE DIFFUSERS

## ADJUST PATTERN DEFLECTORS

**Applicable Models: SCDA and ASCDA**

Adjust the pattern controllers by inserting a screwdriver into the existing tabs and bending the pattern controllers to the desired position.

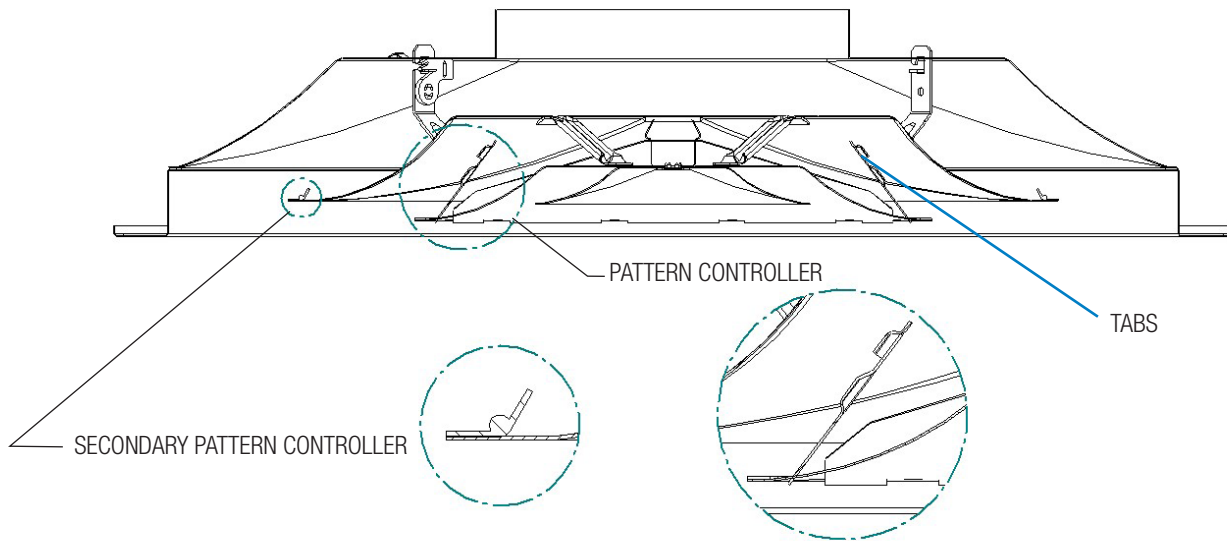

### VERTICAL AIR PATTERN ▼

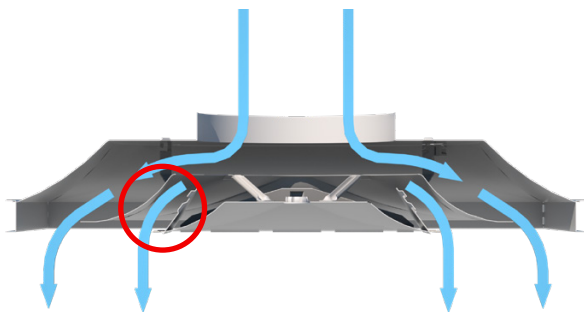

### HORIZONTAL AIR PATTERN ▼

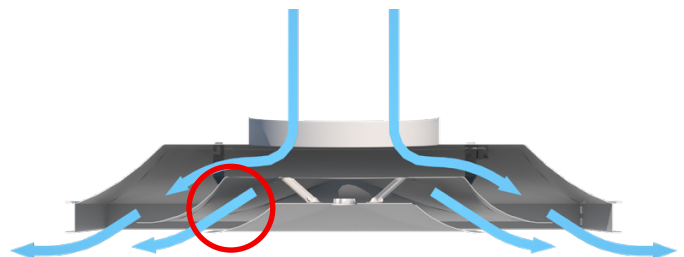

# PRICE SQUARE DIFFUSERS

## PLASTER FRAME INSTALLATION INSTRUCTIONS

### Plaster Frame Without Mounting Clips



**Step 1:** If no mounting clips were ordered, provide blocking around opening (by others). See table below for ceiling opening and blocking.

Plaster Frame	Ceiling Opening
APF	Diffuser Face Size + 7/16"
SPF	Diffuser Face Size + 1/4"
AMF	Diffuser Face Size + 1/2"



**Step 2:** Screw the frame into the blocking (by others).

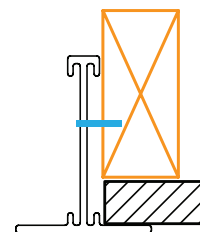
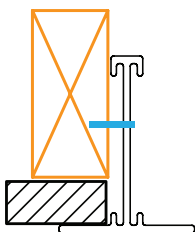

**Step 3:** Lay the diffuser onto the plaster frame.

# PRICE SQUARE DIFFUSERS

## PLASTER FRAME INSTALLATION INSTRUCTIONS

### Plaster Frame With Mounting Clips

**Step 1:** Create a ceiling opening using the table below. Slide the mounting clips into the frame and align with the ceiling opening.

Plaster Frame	Ceiling Opening
APF	Diffuser Face Size + 7/16"
SPF	Diffuser Face Size + 1/4"
AMF	Diffuser Face Size + 1/2"

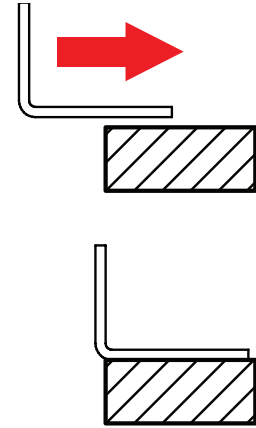
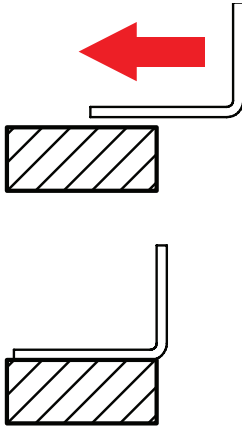

**Step 2:** Screw the plaster frame to the mounting clip. The w should be in between the plaster frame flange and mounting clips.

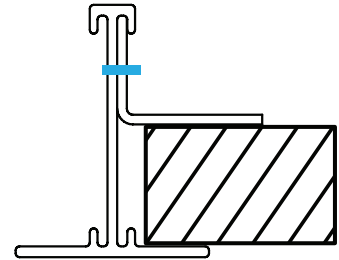
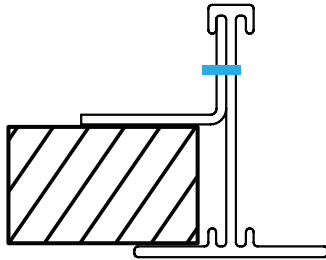

**Step 3:** Lay the diffuser on the plaster frame.

# PRICE SQUARE DIFFUSERS

## PARTS LIST

Part Name	Description	Part Number	Order Model
Core Locking Clip	Inner Core Nylon Locking Clip	041122	GRD-PARTS
PLQ	SPD Face Plaque Subassembly	500520-001	GRD-PARTS
	ASPD Face wPlaque Subassembly	506050-001	GRD-PARTS

### Accessories

Part Name	Description	Part Number	Order Model
AB	Air Baffle (1W, 2W, 3C and 3W pattern)	506220	AB
Z-Clip	Z clips for Sectorizing and Air Baffles	026411	GRD-PARTS
SB	Sectorizing Baffles	900086	SB
APF	Aluminum Plaster Frame	246845	APF
	APF Mounting Clips (optional)	236778	Special*
SPF	Steel Plaster Frame	232988	SPF
AMF	Aluminum Mounting Frame	229164	AMF
Clips	SPF/AMF Mounting Clips (optional)	205207	Special*
Fourth Cone	Steel SCD-ASCD 4th Cone Kit	503678-001	GRD-PARTS
	Aluminum SCD-ASCD 4th Cone Kit	504353-001	GRD-PARTS
VCR7	Radial Opposed Blade Damper (Inlet sizes: 6" to 12")	501212	VCR7
	Radial Opposed Blade Damper (Inlet sizes: 14" and 15")	222435	
VCR8	Full Flow Damper Duct Mounted (Inlet sizes: 4" to 15")	222836	VCR8
VCR8EC	Full Flow Damper Diffuser Mounted (Inlet sizes: 4" to 15")	222835	VCR8E
VCR9	Radial Damper Diffuser Mounted (Inlet sizes: 6" to 14")	238305	VCR9
EHT	Extended Hanger Tab	900200	GRD-PARTS

\* Part is not available as a standard and would need to be ordered as a special at this time, please reach out to your local sales representative.

---

This document contains the most current product information as of this printing.  
For the most up-to-date product information, please go to [priceindustries.com](https://priceindustries.com)

© 2023 Price Industries Limited. All rights reserved.



The Science of Comfort™